

MMR-40

MediaMaster® NMEA 2000®
Network Controller

Product Description

The MMR-40 is a NMEA 2000® network controller designed to add full-function auxiliary control to MediaMaster® source units. Featuring a color LCD display and water-resistant (IP66 rated) design, the MMR-40 connects directly to vessel networks using applicable NMEA 2000® cables and connectors (sold separately).

Note: The MMR-40 is not a stand-alone receiver and does not function without a connected MediaMaster® source unit. All remote control functionality of the MMR-40 is solely derived from the host source unit. Functionality of the MMR-40 requires connection to a NMEA 2000® network or use of MMC-PN2K powered network cables (sold separately).

What Is Included?

- (1) MMR-40 Network Controller
- (1) Mounting gasket
- (1) Mounting template
- (4) Mounting screws
- (1) Protective sun cover
- (1) User Manual









Safety Considerations

- While this product is designed to be water-resistant, it should never be submerged under water or subjected to high-pressure water spray.
- Do not mount in areas of extreme heat.
- Ensure this product is securely installed so that it does not come loose in the event of a collision/sudden jolt or as a result or repeated vibrations during normal operation.
- Check before drilling to make sure that you will not be drilling into a fuel tank, gas/brake line, wiring harness, or other vital system.
- Secure all wiring as needed, using cable ties or wire clamps to protect them from moving parts and sharp edges.
- Always follow proper safety procedures and wear eye-protection at all times with a dust mask and gloves when cutting.

General Command Functions

Below is a list of general source unit functions that are controlled by the MMR-40.

Note: The functionality of some commands will vary depending on the specific MediaMaster® source unit connected to the network.

Button / Description	General Source Unit Functions
 SOURCE Power/Source	<ul style="list-style-type: none"> • Press to turn ON • Press and hold to turn OFF • Press to display the SOURCE: Select menu
 VOL/SEL (Knob) Volume/Select	<ul style="list-style-type: none"> • Rotate to adjust volume • Rotate to scroll thru menu options • Press to choose/enter (menu options)
 Back/Menu	<ul style="list-style-type: none"> • Press to go back or return to the previous screen • Press to access available menu options
 Favorites	<ul style="list-style-type: none"> • Press and hold to store a channel/station as a preset • Press to view your list of stored presets and to access the Favorites: Edit menu.
 Settings	<ul style="list-style-type: none"> • Press to access the Tone, Balance & Crossover menu • Press and hold to access the System Settings: Main Menu
 Forward	<ul style="list-style-type: none"> • Press to tune in the next frequency/station/track • Press and hold to seek to the next channel or skip forward/fast-forward
 Backward	<ul style="list-style-type: none"> • Press to tune in the previous frequency/station/track • Press and hold to seek to the previous channel or skip backward/fast-rewind
 Mute/Play/ Pause	<ul style="list-style-type: none"> • Press to mute/unmute/pause/resume audio • Press and hold to access available Play options
 Day/Night	<ul style="list-style-type: none"> • Press to toggle between Day/Night display settings of the MMR-40 • Press and hold to access the System Settings: Display menu of the MMR-40

Connections

The MMR-40 is equipped with a NMEA 2000® Micro-C connector and can connect to a host MediaMaster® source unit in the two methods shown below. The USB connector is used for future software updates.

- Direct interface with a vessel's NMEA 2000® network using applicable NMEA 2000® cables and connectors (not included).

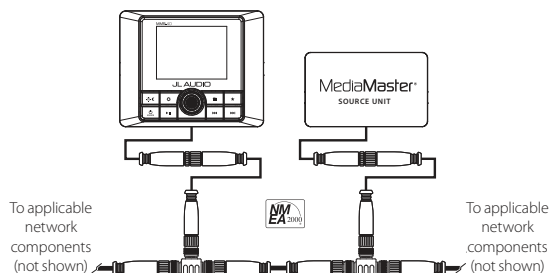

- Direct connection of one MMR-40 with one host MediaMaster® source unit using JL AUDIO® MMC-PN2K powered network cables (sold separately) to simulate an isolated, stand-alone NMEA 2000® network.

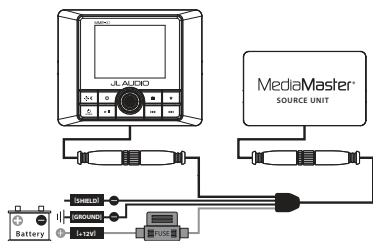

Note: JL Audio® Powered Network Cables support a maximum of two NMEA 2000® devices. For systems with additional NMEA 2000® devices, a genuine NMEA 2000® network must be assembled, which does not support JL Audio® Powered Network Cables.

Mounting & Installation

The diagram below shows a typical mounting procedure into a fiberglass panel. A mounting template is included to aid in measuring and marking the mounting surface before cutting or drilling.

! IMPORTANT

Make sure to carefully plan the routing of the remote's connection cables prior to cutting or drilling any panels.

1. Press along the perforation to remove the center section of the mounting template. (Discard the center section.) The template can be used to verify there is sufficient flat surface area for mounting and as a guide for cutting the opening. Tape the template to the mounting location and mark the surface for cutting the opening and drilling pilot holes.
2. Use a jigsaw or rotary tool to cut an opening in the mounting surface. If necessary, use a file or sandpaper to adjust the opening for proper fitment and smooth the edges.
3. Place the MMR-40 into the opening and check that the mounting holes remain aligned with the pilot hole marks from the template. If not, adjust and mark new holes as necessary.

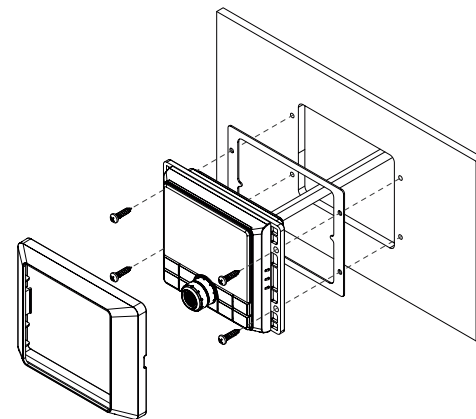

4. Remove the MMR-40 and drill four (4) pilot holes in the mounting surface at the pilot hole marks.
5. Peel the adhesive backing from the mounting gasket and affix to the rear of the bezel. Connect all wiring and place the MMR-40 into the opening.
6. Secure the MMR-40 using the four (4) mounting screws. Press the trim ring onto the front of the MMR-40.

2-Year Limited Warranty (U.S.A.)
Visit www.jlaudio.com for warranty details.

For Service Information in the U.S.A. please call JL Audio customer service: (954) 443-1100 during normal business hours (Eastern Time)
JL Audio, Inc • 10369 N Commerce Parkway, Miramar, FL 33025

International Warranties:
Products purchased outside the United States of America are covered only by that country's distributor and not by JL Audio, Inc.

MMR40-MAN 080918 • Printed in China